

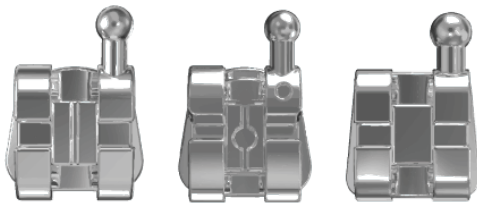

DokSalamat

Orthodontic Brackets





Metal Brackets Series

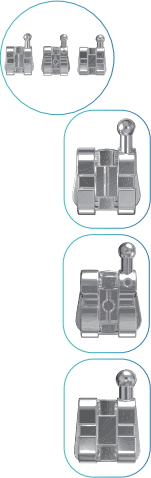

www.doksalamat.com

Orthodontic Bracket Features

Table Of Content

IMAGE	NAME	FEATURES	PAGES
	BM	80 Mesh Base + Mini/Standard Size	03 - 06
	BN	Monoblock Design	07 - 10
	ML	Monoblock Design + Sand blasting for option	11 - 12
	Lingual	Special design for lingual side	13 - 14

ABOUT PRODUCT

Metal Brackets

“

Adopt the Material and MIM technology, ensure the accuracy of product size and angle.

BM

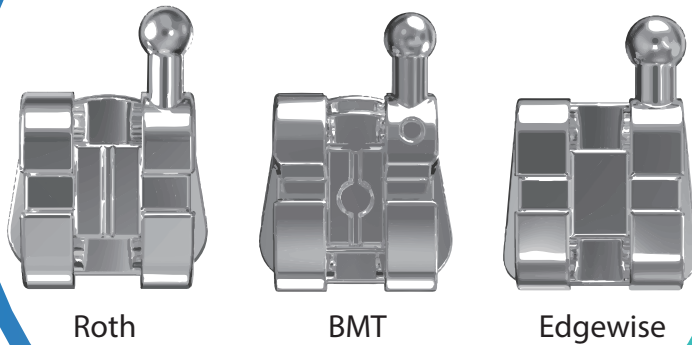

Metal Bracket Series (BM)

It is divided into mini size and standard size according to size.

80 mesh base for max adhesion.

Adopt the 17-4 row material and MIM technology, ensure the accuracy of product size and angle.

Small bracket profile and size with rounded corner design for the comfort of the wearer.

Color marks are used to distinguish different intervals, increase recognition and improve accuracy in use .

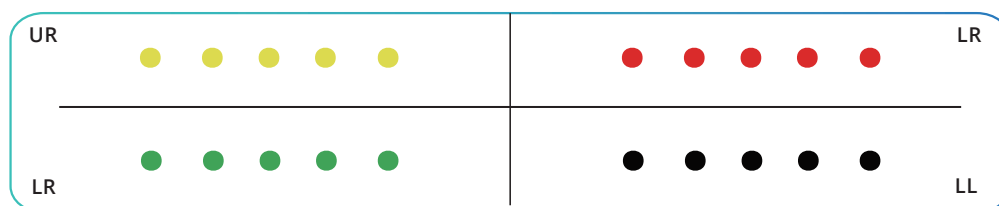

BRACKET FEATURES

Metal Bracket Series (BM)

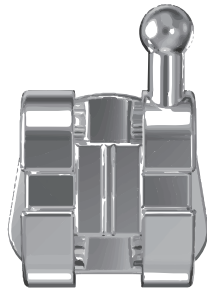

ROTH

Hook	Mini Parts No. 0.018" / 0.022"	Standard Parts No. 0.018" / 0.022"
Without hooks	11R1-010	11R1-020
With 3 hooks	11R1-013	1113-023
With 345 hooks	11R1-015	1115-025

Maxillary	Torque	Tip	Mini item No. 0.018" / 0.022"		Standard Item No. 0.018" / 0.022"		
			(R)	(L)	(R)	(L)	
U1	Central	12°	5°	11R1-01011	11R1-01021	11R1-02011	11R1-02021
U2	Lateral	8°	9°	11R1-01012	11R1-01022	11R1-02012	11R1-02022
U3	Cupid without hook	-2°	10°	11R1-01013	11R1-01023	11R1-02013	11R1-02023
	Cupid with hook	-7°	10°	11R1-01313	11R1-01323	11R1-02313	11R1-02323
U4	1st Bicuspid without hook	-7°	0°	11R1-01014	11R1-01024	11R1-02014	11R1-02024
	1st Bicuspid with hook	-7°	0°	11R1-01514	11R1-01524	11R1-02514	11R1-02524
U5	2nd Bicuspid without hook	-7°	0°	11R1-01015	11R1-01025	11R1-02015	11R1-02025
	2nd Bicuspid with hook	-7°	0°	11R1-01515	11R1-01525	11R1-02515	11R1-02525

Mandibular	Torque	Tip	Mini item No. 0.018" / 0.022"		Standard Item No. 0.018" / 0.022"		
			(R)	(L)	(R)	(L)	
L1	Central	-1°	0°	11R1-01041	11R1-01031	11R1-02041	11R1-02031
L2	Lateral	-1°	0°	11R1-01042	11R1-01032	11R1-02042	11R1-02032
L3	Cupid without hook	-11°	7°	11R1-01043	11R1-01033	11R1-02043	11R1-02033
	Cupid with hook	-11°	7°	11R1-01343	11R1-01333	11R1-02343	11R1-02333
L4	1st Bicuspid without hook	-17°	0°	11R1-01044	11R1-01034	11R1-02044	11R1-02034
	1st Bicuspid with hook	-17°	0°	11R1-01544	11R1-01534	11R1-02544	11R1-02534
L5	2nd Bicuspid without hook	-22°	0°	11R1-01045	11R1-01035	11R1-02045	11R1-02035
	2nd Bicuspid with hook	-22°	0°	11R1-01545	11R1-01535	11R1-02545	11R1-02534

BRACKET FEATURES

Metal Bracket Series (BM)

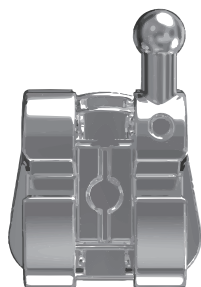

BMT

Hook	Mini Parts No. 0.018" / 0.022"	Standard Parts No. 0.018" / 0.022"
Without hooks	11R1-010	11R1-020
With 3 hooks	11R1-013	1113-023
With 345 hooks	11R1-015	1115-025

Maxillary	Torque	Tip	Mini item No. 0.018" / 0.022"		Standard Item No. 0.018" / 0.022"		
			(R)	(L)	(R)	(L)	
U1 Central	17°	4°	11M1-01011	11M1-01021	11M1-02011	11M1-02021	
U2 Lateral	10°	8°	11M1-01012	11M1-01022	11M1-02012	11M1-02022	
U3 Cupid	without hook	-7°	8°	11M1-01013	11M1-01023	11M1-02013	11M1-02023
	with hook	-7°	8°	11M1-01313	11M1-01323	11M1-02313	11M1-02323
U4 1st Bicuspid	without hook	-7°	0°	11M1-01014	11M1-01024	11M1-02014	11M1-02024
	with hook	-7°	0°	11M1-01514	11M1-01524	11M1-02514	11M1-02524
U5 2nd Bicuspid	without hook	-7°	0°	11M1-01015	11M1-01025	11M1-02015	11M1-02025
	with hook	-7°	0°	11M1-01515	11M1-01525	11M1-02515	11M1-02525

Mandibular	Torque	Tip	Mini item No. 0.018" / 0.022"		Standard Item No. 0.018" / 0.022"		
			(R)	(L)	(R)	(L)	
L1 Central	-6°	0°	11M1-01041	11M1-01031	11M1-02041	11M1-02031	
L2 Lateral	-6°	0°	11M1-01042	11M1-01032	11M1-02042	11M1-02032	
L3 Cupid	without hook	-6°	3°	11M1-01043	11M1-01033	11M1-02043	11M1-02033
	with hook	-6°	3°	11M1-01343	11M1-01333	11M1-02343	11M1-02333
L4 1st Bicuspid	without hook	-12°	0°	11M1-01044	11M1-01034	11M1-02044	11M1-02034
	with hook	-16°	0°	11M1-01544	11M1-01534	11M1-02544	11M1-02534
L5 2nd Bicuspid	without hook	-17°	0°	11M1-01045	11M1-01035	11M1-02045	11M1-02035
	with hook	-17°	0°	11M1-01545	11M1-01535	11M1-02545	11M1-02534

BRACKET FEATURES

Metal Bracket Series (BM)



EDGEWISE

Hook	Mini Parts No. 0.018" / 0.022"	Standard Parts No. 0.018" / 0.022"
Without hooks	11R1-070	11R1-080
With 3 hooks	11R1-073	1113-083
With 345 hooks	11R1-075	1115-085

Maxillary	Torque	Tip	Mini item No. 0.018" / 0.022"		Standard Item No. 0.018" / 0.022"		
			(R)	(L)	(R)	(L)	
U1	Central	0°	0°	11R1-07011	11R1-07021	11R1-08011	11R1-08021
U2	Lateral	0°	0°	11R1-07012	11R1-07022	11R1-08012	11R1-08022
U3	Cupid without hook	0°	0°	11R1-07013	11R1-07023	11R1-08013	11R1-08023
	Cupid with hook	0°	0°	11R1-07313	11R1-07323	11R1-08313	11R1-08323
U4	1st Bicuspid without hook	0°	0°	11R1-07014	11R1-07024	11R1-08014	11R1-02024
	1st Bicuspid with hook	0°	0°	11R1-07514	11R1-07524	11R1-08514	11R1-08524
U5	2nd Bicuspid without hook	0°	0°	11R1-07015	11R1-07025	11R1-08015	11R1-02025
	2nd Bicuspid with hook	0°	0°	11R1-07515	11R1-07525	11R1-08515	11R1-08525

Mandibular	Torque	Tip	Mini item No. 0.018" / 0.022"		Standard Item No. 0.018" / 0.022"		
			(R)	(L)	(R)	(L)	
L1	Central	0°	0°	11R1-07041	11R1-07031	11R1-08041	11R1-08031
L2	Lateral	0°	0°	11R1-07042	11R1-07032	11R1-08042	11R1-08032
L3	Cupid without hook	0°	0°	11R1-07043	11R1-07033	11R1-08043	11R1-08033
	Cupid with hook	0°	0°	11R1-07343	11R1-07333	11R1-08343	11R1-08333
L4	1st Bicuspid without hook	0°	0°	11R1-07044	11R1-07034	11R1-08044	11R1-08034
	1st Bicuspid with hook	0°	0°	11R1-07544	11R1-07534	11R1-08544	11R1-08534
L5	2nd Bicuspid without hook	0°	0°	11R1-07045	11R1-07035	11R1-08045	11R1-08035
	2nd Bicuspid with hook	0°	0°	11R1-07545	11R1-07535	11R1-08545	11R1-08534

BN

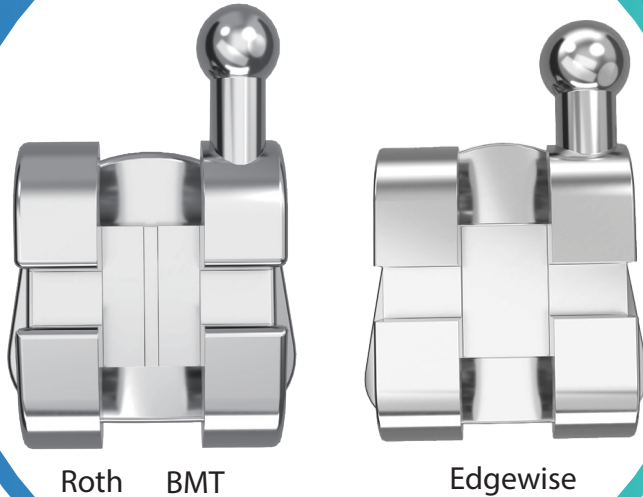

Roth BMT

Edgewise

Metal Bracket Series (BN)

Adopt the 17-4 row material and MIM technology, ensure the accuracy of product size and angle.

Ensure the accuracy of product size and angle by moboblock design.

The centerline for adjustment of position and angle.

The rounded corner design for the comfort of the wearer.

BRACKET FEATURES

Metal Bracket Series (BN)



ROTH

Hook

**Item No.
0.022"**

Without hooks	11R1-050
With 3 hooks	11R1-053
With 345 hooks	11R1-055

Maxillary		Torque	Tip	Part No. 0.018" / 0.022" (R) (L)	
U1	Central	12°	5°	11R1-03011	11R1-03021
U2	Lateral	8°	9°	11R1-03012	11R1-03022
U3	Cupid without hook	-2°	10°	11R1-03013	11R1-03023
	Cupid with hook	-2°	10°	11R1-03313	11R1-03323
U4	1st Bicuspid without hook	-7°	0°	11R1-03014	11R1-03024
	1st Bicuspid with hook	-7°	0°	11R1-03514	11R1-03524
U5	2nd Bicuspid without hook	-7°	0°	11R1-03015	11R1-03025
	2nd Bicuspid with hook	-7°	0°	11R1-03515	11R1-03525

Mandibular		Torque	Tip	Part No. 0.018" / 0.022" (R) (L)	
L1	Central	-1°	0°	11R1-03041	11R1-03031
L2	Lateral	-1°	0°	11R1-03042	11R1-03032
L3	Cupid without hook	-11°	7°	11R1-03043	11R1-03033
	Cupid with hook	-11°	7°	11R1-03343	11R1-03333
L4	1st Bicuspid without hook	-17°	0°	11R1-03044	11R1-03034
	1st Bicuspid with hook	-17°	0°	11R1-03544	11R1-03534
L5	2nd Bicuspid without hook	-22°	0°	11R1-03045	11R1-03035
	2nd Bicuspid with hook	-22°	0°	11R1-03545	11R1-03535

BRACKET FEATURES

Metal Bracket Series (BN)

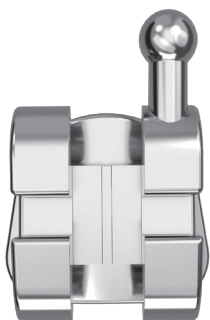

BMT

Hook

Item No.
0.018" / 0.022"

Without hooks	11M1-030
With 3 hooks	11M1-033
With 345 hooks	11M1-035

Maxillary		Torque	Tip	Part No. 0.018" / 0.022"	
				(R)	(L)
U1	Central	17°	4°	11M1-03011	11M1-03021
U2	Lateral	10°	8°	11M1-03012	11M1-03022
U3	Cupid without hook	-7°	8°	11M1-03013	11M1-03023
	Cupid with hook	-7°	8°	11M1-03313	11M1-03323
U4	1st Bicuspid without hook	-7°	0°	11M1-03014	11M1-03024
	1st Bicuspid with hook	-7°	0°	11M1-03514	11M1-03524
U5	2nd Bicuspid without hook	-7°	0°	11M1-03015	11M1-03025
	2nd Bicuspid with hook	-7°	0°	11M1-03515	11M1-03525

Mandibular		Torque	Tip	Part No. 0.018" / 0.022"	
				(R)	(L)
L1	Central	-6°	0°	11M1-03041	11M1-03031
L2	Lateral	-6°	0°	11M1-03042	11M1-03032
L3	Cupid without hook	-6°	3°	11M1-03043	11M1-03033
	Cupid with hook	-6°	3°	11M1-03343	11M1-03333
L4	1st Bicuspid without hook	-12°	0°	11M1-03044	11M1-03034
	1st Bicuspid with hook	-12°	0°	11M1-03544	11M1-03534
L5	2nd Bicuspid without hook	-17°	0°	11M1-03045	11M1-03035
	2nd Bicuspid with hook	-17°	0°	11M1-03545	11M1-03535

BRACKET FEATURES

Metal Bracket Series (BN)



EDGEWISE

Hook	Item No. 0.018" / 0.022"
Without hooks	11R1-030
With 3 hooks	11R1-033
With 345 hooks	11R1-035

	Maxillary	Torque	Tip	Part No.	
				(R)	(L)
U1	Central	0°	0°	11R1-05011	11R1-05021
U2	Lateral	0°	0°	11R1-05012	11R1-05022
U3	Cupid without hook	0°	0°	11R1-05013	11R1-05023
	Cupid with hook	0°	0°	11R1-05313	11R1-05323
U4	1st Bicuspid without hook	0°	0°	11R1-05014	11R1-05024
	1st Bicuspid with hook	0°	0°	11R1-05514	11R1-05524
U5	2nd Bicuspid without hook	0°	0°	11R1-05015	11R1-05025
	2nd Bicuspid with hook	0°	0°	11R1-05515	11R1-05525

	Mandibular	Torque	Tip	Part No.	
				(R)	(L)
L1	Central	0°	0°	11R1-05041	11R1-05031
L2	Lateral	0°	0°	11R1-05042	11R1-05032
L3	Cupid without hook	0°	0°	11R1-05043	11R1-05033
	Cupid with hook	0°	0°	11R1-05343	11R1-05333
L4	1st Bicuspid without hook	0°	0°	11R1-05044	11R1-05034
	1st Bicuspid with hook	0°	0°	11R1-05544	11R1-05534
L5	2nd Bicuspid without hook	0°	0°	11R1-05045	11R1-05035
	2nd Bicuspid with hook	0°	0°	11R1-05545	11R1-05535

BRACKET FEATURES

Metal Brackets Series (ML)

ROTH MBT

Hook	Item No. 0.018" / 0.022"
Without hooks	11R1-030
With 3 hooks	11R1-033
With 345 hooks	11R1-035

Maxillary		ROTH				MBT			
		Torque	Tip	Parts No. 0.018" / 0.022" (R) (L)		Torque	Tip	Parts No. 0.018" / 0.022" (R) (L)	
U1	Central	12°	5°	11R1-04011	11R1-04021	17°	4°	11M1-04011	11M1-04021
U2	Lateral	8°	9°	11R1-04012	11R1-04022	10°	8°	11M1-04012	11M1-04022
U3	Cupid without hook	-2°	10°	11R1-04013	11R1-04023	-7°	8°	11M1-04013	11M1-04023
	Cupid with hook	-2°	10°	11R1-04313	11R1-04323	-7°	8°	11M1-04313	11M1-04323
U4	1st Bicuspid without hook	-7°	0°	11R1-04014	11R1-04024	-7°	0°	11M1-04014	11M1-04024
	1st Bicuspid with hook	-7°	0°	11R1-04514	11R1-04524	-7°	0°	11M1-04514	11M1-04524
U5	2nd Bicuspid without hook	-7°	0°	11R1-04015	11R1-04 025	-7°	0°	11M1-04015	11M1-04 025
	2nd Bicuspid with hook	-7°	0°	11R1-04515	11R1-07525	-7°	0°	11M1-04515	11M1-07525

Mandibular		ROTH				MBT			
		Torque	Tip	Parts No. 0.018" / 0.022" (R) (L)		Torque	Tip	Parts No. 0.018" / 0.022" (R) (L)	
U1	Central	-1°	0°	11R1-04041	11R1-04031	-6°	0°	11M1-04041	11M1-04031
U2	Lateral	-1°	0°	11R1-04042	11R1-04032	-6°	0°	11M1-04042	11M1-04032
U3	Cupid without hook	-11°	7°	11R1-04043	11R1-04033	-6°	3°	11M1-04043	11M1-04033
	Cupid with hook	-11°	7°	11R1-04343	11R1-04333	-6°	3°	11M1-04343	11M1-04333
U4	1st Bicuspid without hook	-17°	0°	11R1-04044	11R1-04034	-12°	0°	11M1-04044	11M1-04034
	1st Bicuspid with hook	-17°	0°	11R1-04544	11R1-04534	-12°	0°	11M1-04544	11M1-04534
U5	2nd Bicuspid without hook	-22°	0°	11R1-04045	11R1-04 035	-17°	0°	11M1-04045	11M1-04 035
	2nd Bicuspid with hook	-22°	0°	11R1-04545	11R1-07535	-17°	0°	11M1-04545	11M1-07535

ML



Metal Brackets Series (ML)

Sand blasting process can be selected to provide stronger bonding strength.

The hook with lengthened to provide more convenient traction support.

Adopt the 17-4 row material and MIM technology.

Ensure the accuracy of product size and angle by moboblock design.

The centerline for adjustment of position and angle.

Permanent ID Marking for identification.

The rounded corner design for the comfort of the wearer.

Lingual



Metal Brackets Series (Lingual Brackets)

Adopt the 17-4 row material and MIM technology, ensure the accuracy of product size and angle.

The rounded corner design for the comfort of the wearer.

BRACKET FEATURES

Metal Brackets Series (Lingual Brackets)

LINGUAL

With Hook

Item No.

0.022"

11R1-315

	Maxillary	Torque	Tip	Part No.	
				(R)	(L)
U1	Central	-55°	0°	11R1-31511	11R1-31521
U2	Lateral	-55°	0°	11R1-31512	11R1-31522
U3	Cuspids	-55°	0°	11R1-31513	11R1-31523
U4	1st Bicuspid	-11°	0°	11R1-31514	11R1-31524
U5	2nd Bicuspid	-11°	0°	11R1-31515	11R1-31525

	Mandibular	Torque	Tip	Part No.	
				(R)	(L)
U1	Central	-40°	0°	11R1-31541	11R1-31531
U2	Lateral	-40°	0°	11R1-31542	11R1-31532
U3	Cuspids	-40°	0°	11R1-31543	11R1-31533
U4	1st Bicuspid	-11°	0°	11R1-31544	11R1-31534
U5	2nd Bicuspid	-11°	0°	11R1-31545	11R1-31535



+63 917 148 0371
+63 44 762 3252



contact-us@doksalamat.com



Bldg. 167 Unit 3 Ezekiel Street
Masuso, Pandi, Bulacan,
Philippines